

Schaukelgerüst mit Vogelnest

Gerätelinie Robinie











Artikel 40182

Schaukelgerüst aus chemisch unbehandeltem Robinienkernholz geschliffen, Aufhängevorrichtung aus Edelstahl für zwei Sitze, Stahlrohr und Eckverbinder feuerverzinkt, mit Vogelnest Huck ø 125 cm, Seilringfarbe beige.



CHF 5'550.-

(exkl. MWST)

 Altersgruppe	3+
 Gerätemasse	653 x 230 x 272 cm
 Platzbedarf	795 x 653 cm
 min. Aufprallfläche	41.85 m ²
 Fallhöhe	146 cm
 schwerstes Element	60 kg
 grösstes Element	370 x 16 x 16 cm
 Fundamente	6
 Beton	1.2 m ³
 Montagezeit	3 h
 Monteure	2

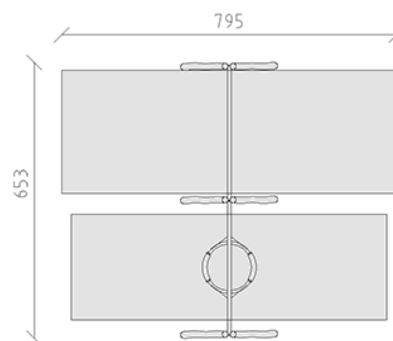

buerli
Mitten im Spiel