

# Schaukelgerüst mit Vogelnest

Gerätelinie Kantholz











Artikel 32226

Schaukelgerüst mit Vogelnest aus mehrfach verleimtem Kiefernholz druckimprägniert, Aufhängevorrichtung aus Edelstahl für zwei Sitze, Stahlrohr und Eckverbinder feuerverzinkt, Vogelnest ø 115 cm, inkl. Stahlfusskonsolen für minimale Einbautiefe 50 cm.



**CHF 4'575.-**

(exkl. MWST)

 Altersgruppe	3+
 Gerätemasse	623 x 218 x 262 cm
 Platzbedarf	794 x 623 cm
 min. Aufprallfläche	40.85 m <sup>2</sup>
 Fallhöhe	146 cm
 schwerstes Element	45 kg
 grösstes Element	320 x 38 x 28 cm
 Fundamente	6
 Beton	1.1 m <sup>3</sup>
 Montagezeit	2 h
 Monteure	2

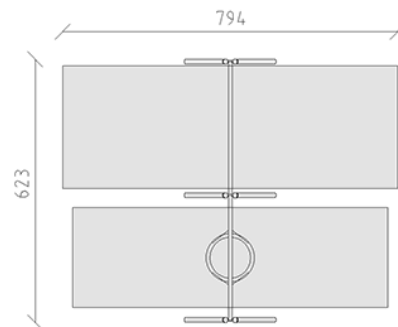

**buerli**  
Mitten im Spiel