

Balancierkahn klein

Gerätelinie Robinie











Artikel 43980

Balancierkahn aus chemisch unbehandeltem Robinienkernholz geschliffen, Podesthöhe 150 cm, mit Pultdach, Sprossenaufstieg, Schrägaufstieg, verdrehte Leiter, Rutschbahn aus Polyester rot/anthrazit und Balancier-Parcours.



CHF 23'320.-

(exkl. MWST)

 Altersgruppe	3+
 Gerätemasse	1103 x 480 x 383 cm
 Platzbedarf	1464 x 795 cm
 min. Aufprallfläche	74.4 m ²
 Fallhöhe	150 cm
 schwerstes Element	540 kg
 grösstes Element	217 x 170 x 463 cm
 Fundamente	22
 Beton	3.3 m ³
 Montagezeit	7 h
 Monteure	3

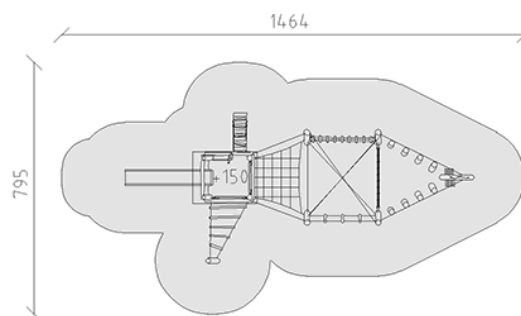

buerli
Mitten im Spiel