

Riesenschaukel

Gerätelinie Robinie

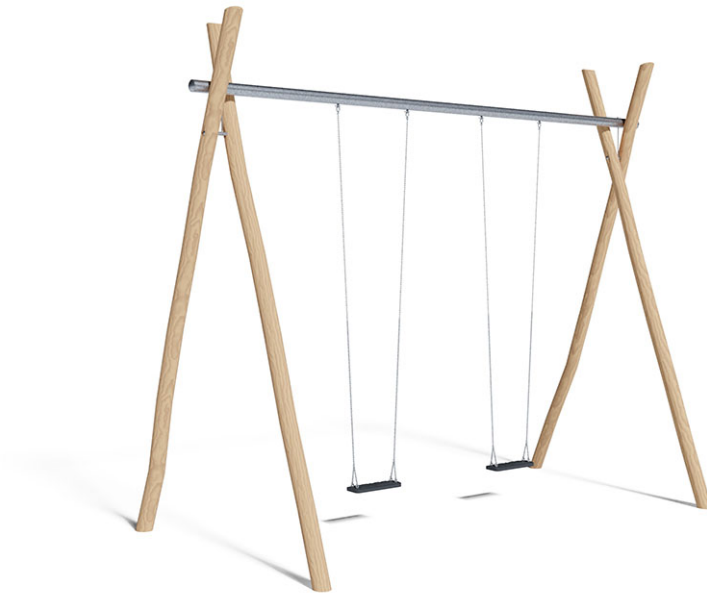









Artikel 40196

Riesenschaukel aus chemisch unbehandeltem Robinienkernholz geschliffen, Höhe 467 cm, Aufhängevorrichtung aus Edelstahl für zwei Sitze, Stahlrohr feuerverzinkt.



CHF 4'910.-

(exkl. MWST)

| | |
|---------------------------------------------------------------------------------------------------------|---------------------|
|  Altersgruppe | 3+ |
|  Gerätemasse | 555 x 285 x 467 cm |
|  Platzbedarf | 1078 x 555 cm |
|  min. Aufprallfläche | 36.8 m ² |
|  Fallhöhe | 220 cm |
|  schwerstes Element | 90 kg |
|  grösstes Element | 590 x 14 x 16 cm |
|  Fundamente | 4 |
|  Beton | 2.9 m ³ |
|  Montagezeit | 2 h |
|  Monteure | 2 |

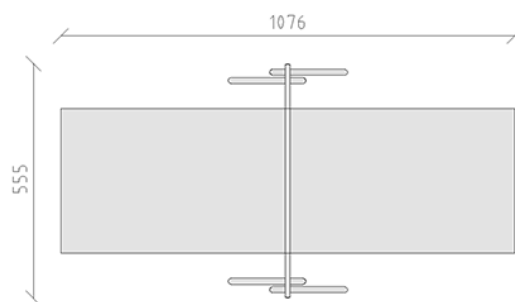

buerli
Mitten im Spiel