

Vogelnest- und Dschungelschaukel

Gerätelinie Kantholz











Artikel 32210

Vogelnest- und Dschungelschaukel aus mehrfach verleimtem Kiefernholz druckimprägniert, Aufhängevorrichtung aus Edelstahl, Stahlrohr und Eckverbinder feuerverzinkt, mit Vogelnest Huck ø 125 cm, Seilringfarbe blau und Dschungelsitz aus geflochtenem Seil, inkl. Stahlfusskonsolen für minimale Einbautiefe 50 cm.



CHF 6'490.-

(exkl. MWST)

	Altersgruppe	3+
	Gerätemasse	588 x 218 x 262 cm
	Platzbedarf	822 x 588 cm
	min. Aufprallfläche	33.05 m ²
	Fallhöhe	199 cm
	schwerstes Element	45 kg
	grösstes Element	285 x 38 x 28 cm
	Fundamente	6
	Beton	1.1 m ³
	Montagezeit	2 h
	Monteure	2

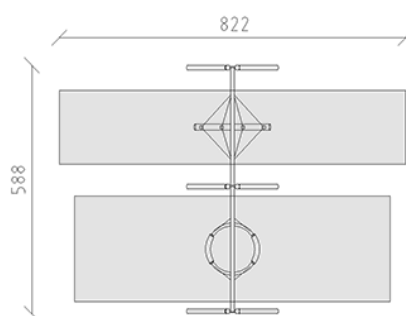

buerli
Mitten im Spiel