

Klettergerüst

Gerätelinie Robinie









Artikel 40270

Klettergerüst aus chemisch unbehandeltem Robinienkernholz geschliffen, Aufhängevorrichtungen aus Edelstahl, Mammutseile stahlarmiert, mit Netzwand, Feuerwehrstange, Strickleiter und Teller-Balance.



CHF 7'845.-

(exkl. MWST)

 Altersgruppe	3+
 Gerätemasse	343 x 255 x 219 cm
 Platzbedarf	724 x 631 cm
 min. Aufprallfläche	39.05 m ²
 Fallhöhe	196 cm
 schwerstes Element	160 kg
 grösstes Element	280 x 200 x 30 cm
 Fundamente	7
 Beton	1.15 m ³
 Montagezeit	5 h
 Monteure	2

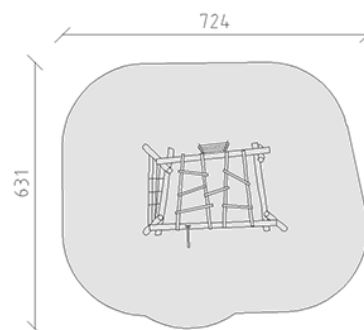

buerli
Mitten im Spiel