

Sand play system

Device line Robinie











Article 43915

Sand play system made of chemically untreated Robinia heartwood, sanded, platform heights 60/90 cm, with gable roof, climbing ramp, painting wall, wall game, sliding crane, sand wheel and slide made of polyester red/yellow.



CHF 14'865.-

(excl. VAT)

 Age group	3+
 Device dimensions	346 x 332 x 309 cm
 Space required	642 x 636 cm
 min. impact surface	31.85 m ²
 Fall height	100 cm
 Heaviest element	480 kg
 Biggest element	370 x 200 x 200 cm
 Foundations	10
 Concrete	1.4 m ³
 Assembly time	3 h
 Installers	2

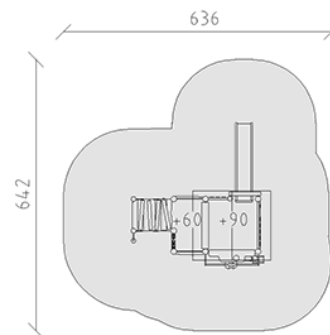

buerli
Center of play

+41 41 925 14 00
info@buerli.swiss