

# Swing frame with Bird's Nest

Device line Robinie











Article 40182

Swing frame made of chemically untreated robinia heartwood, sanded, suspension device made of stainless steel for two seats, steel tube and corner connectors hot-dip galvanised, with bird's nest Huck ø 125 cm, beige rope ring.



**CHF 5'550.-**

(excl. VAT)

 Age group	3+
 Device dimensions	653 x 230 x 272 cm
 Space required	795 x 653 cm
 min. impact surface	41.85 m <sup>2</sup>
 Fall height	146 cm
 Heaviest element	60 kg
 Biggest element	370 x 16 x 16 cm
 Foundations	6
 Concrete	1.2 m <sup>3</sup>
 Assembly time	3 h
 Installers	2

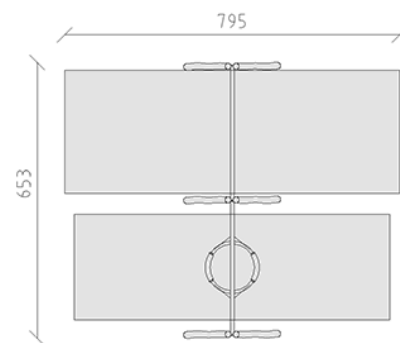

**buerli**  
Center of play

+41 41 925 14 00

info@buerli.swiss