

# Swing frame with Bird's Nest

Device line Kantholz











Article 32226

Swing frame with bird's nest made of multi-glued pine, pressure impregnated, stainless steel suspension device for two seats, steel tube and corner connectors hot-dip galvanised, bird's nest ø 115 cm, incl. steel foot brackets for minimum installation depth 50 cm.



**CHF 4'575.-**

(excl. VAT)

 Age group	3+
 Device dimensions	623 x 218 x 262 cm
 Space required	794 x 623 cm
 min. impact surface	40.85 m <sup>2</sup>
 Fall height	146 cm
 Heaviest element	45 kg
 Biggest element	320 x 38 x 28 cm
 Foundations	6
 Concrete	1.1 m <sup>3</sup>
 Assembly time	2 h
 Installers	2

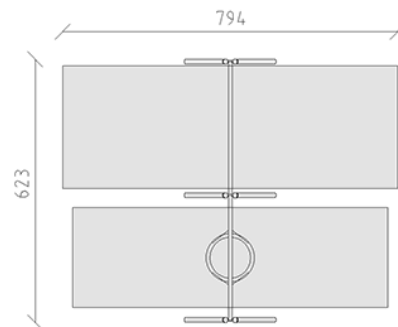

**buerli**  
Center of play