

Swing frame with Bird's Nest

Device line Robinie











Article 40178

Swing frame with bird's nest made of chemically untreated robinia heartwood, sanded, stainless steel suspension device for two seats, corner connectors hot-dip galvanised and additionally lacquered in RAL 7016, with Bird's Nest Huck ø 125 cm, beige rope ring.



CHF 6'290.-

(excl. VAT)

 Age group	3+
 Device dimensions	668 x 225 x 275 cm
 Space required	790 x 668 cm
 min. impact surface	41.65 m ²
 Fall height	146 cm
 Heaviest element	60 kg
 Biggest element	370 x 16 x 16 cm
 Foundations	6
 Concrete	1.2 m ³
 Assembly time	3 h
 Installers	2

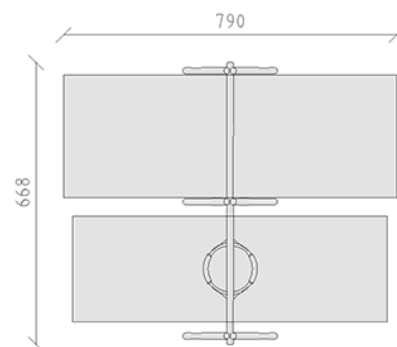

buerli
Center of play

+41 41 925 14 00

info@buerli.swiss