

Swing frame combination

Device line Kantholz











Article 32520

Swing frame combination made of multi-glued Swiss pine, pressure impregnated, platform height 120 cm, slide made of polyester green/green, with lateral trapeze, stainless steel suspension device for one seat, incl. steel foot brackets for minimum installation depth 50 cm.



CHF 4'505.-

(excl. VAT)

	Age group	3+
	Device dimensions	537 x 355 x 241 cm
	Space required	847 x 745 cm
	min. impact surface	45.25 m ²
	Fall height	131 cm
	Heaviest element	110 kg
	Biggest element	200 x 77 x 240 cm
	Foundations	7
	Concrete	1.15 m ³
	Assembly time	3 h
	Installers	2

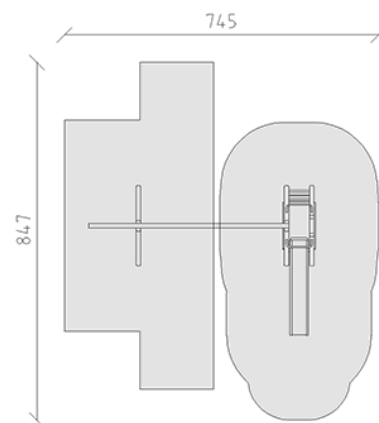

buerli
Center of play

+41 41 925 14 00

info@buerli.swiss