

H= Fallhöhe
H= espace de chute

nicht vermasste Radien bei Aufprallfläche R1500
Espace de chute avec radius sans
indication de mesures R1500

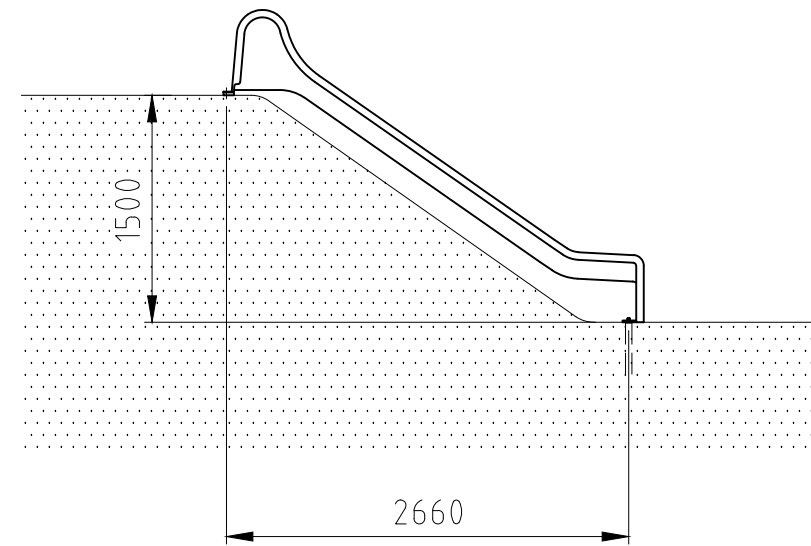

Fundament F09.1

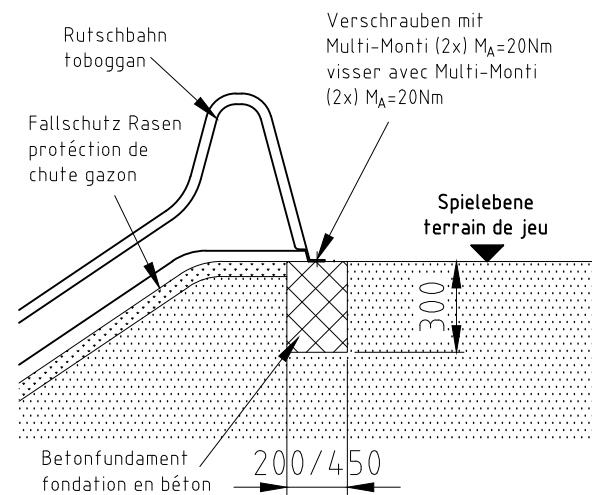

Fundament F09

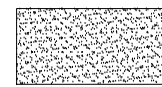
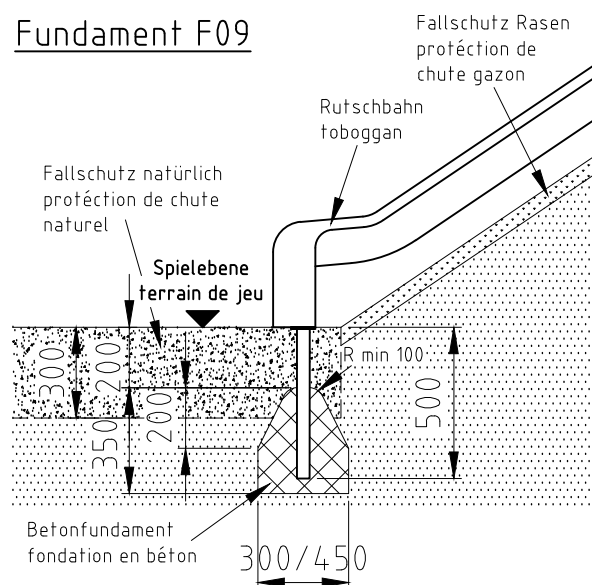

Aufprallfläche 0-200cm /
Schichtdicke min. 30cm
espace de chute 0-200cm /
épaisseur minimale de couche 30cm

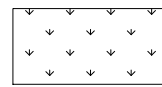

Aufprallfläche 0-100cm
espace de chute 0-100cm

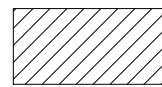

hindernisfreie Zone
zone sans barriere

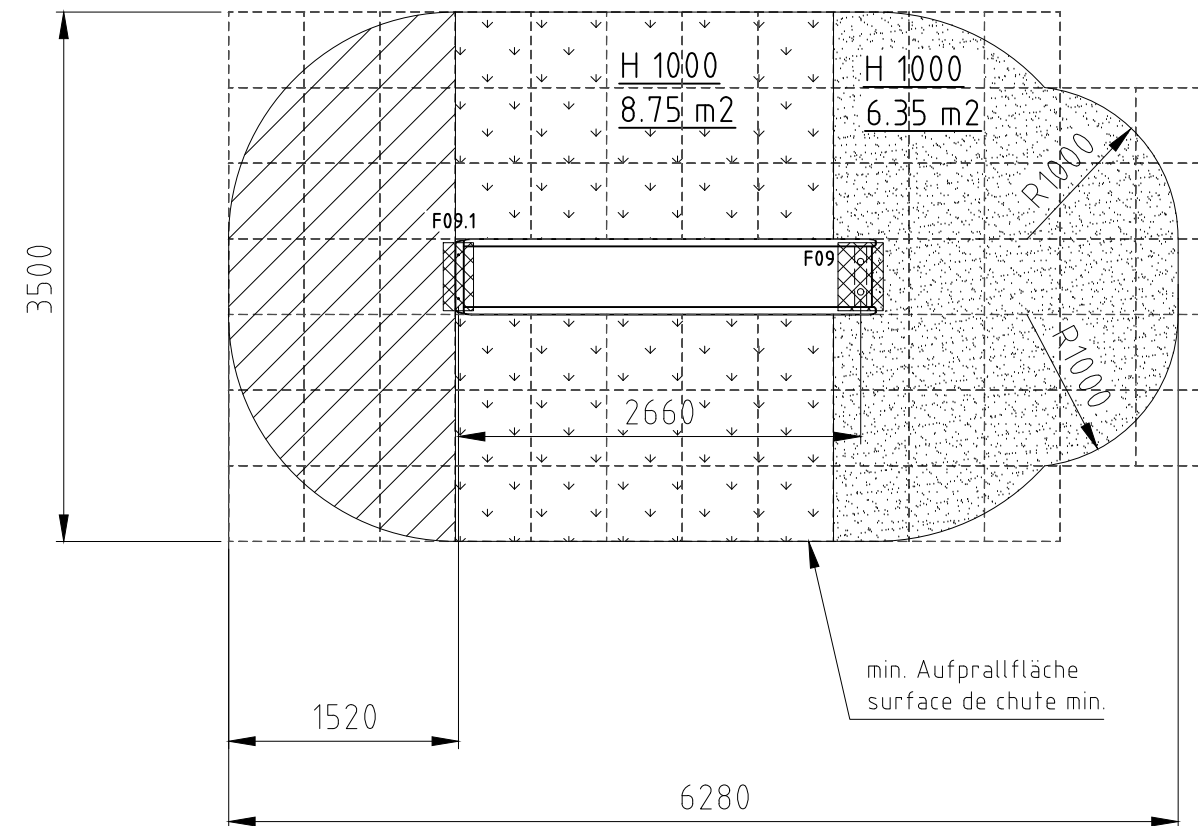

Norm: SN EN 1176-1:2018 SN EN 1177:2018	Datum	Name	Objekt:	
	Gez	22.03.2012	sa	10100-001-n Rutschbahn PH150
Sachbearbeiter			Auftraggeber:	
 Spiel- und Sportgeräte AG CH-6212 St. Erhard Tel 041 925 14 00 info@buerli.swiss			natürlicher Fallschutz / protection de chute naturel	
			Offerte/Auftrag:	Zeichn.-Nr.: 011457
© by www.buerli.swiss			Fundation M: 1:50 Layout: 1 A3	